

# POUTRELLE ALU



**ECHAFAUDAGE**

**ÉTAIEMENT**

**VENTE**

**LOCATION**

**MONTAGE**

**HUSSOR ERECTA**

DES SOMMETS D'EXIGENCE

# CARACTÉRISTIQUES

## PROFILS

### PROFIL 60/165

Section : 11 cm<sup>2</sup>  
 Moment d'inertie xx' : 359 cm<sup>4</sup>  
 Module d'inertie xx' : 43,5 cm<sup>3</sup>  
 Moment de flexion xx' : 615 daN.M  
 T admissible xx' : 2500 daN  
 Moment d'inertie yy' : 74 cm<sup>4</sup>  
 Module d'inertie yy' : 24,3 cm<sup>3</sup>  
 Moment de flexion yy' : 343 daN.M  
 T admissible yy' : 1500 daN  
 Poids au mètre linéaire : 3 kg  
 Longueurs standards : 1,20 m - 2,40 m - 3,60 m - 4,80 m  
 Autres longueurs nous consulter



Modèle déposé.

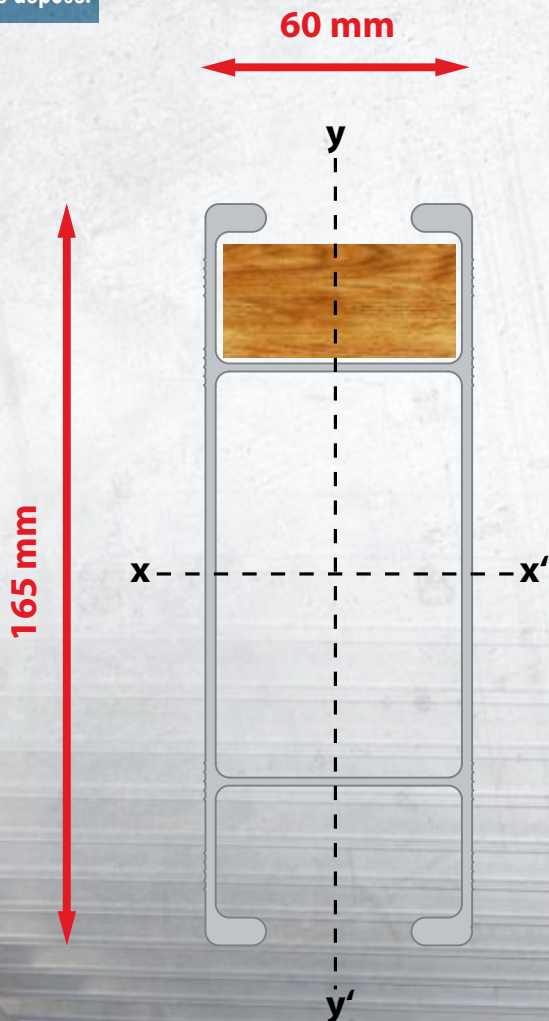

#### Profil Erecta 60/135

réf. 4950 | 1,20 m - 2,40 m - 3,60 m - 4,80 m

### PROFIL 68/200

Section : 20,70 cm<sup>2</sup>  
 Moment d'inertie xx' : 1014 cm<sup>4</sup>  
 Module d'inertie xx' : 101 cm<sup>3</sup>  
 Moment de flexion xx' : 1425 daN.M  
 T admissible xx' : 5000 daN  
 Moment d'inertie yy' : 164 cm<sup>4</sup>  
 Module d'inertie yy' : 49 cm<sup>3</sup>  
 Moment de flexion yy' : 690 daN.M  
 T admissible yy' : 2600 daN  
 Poids au mètre linéaire : 6,2 kg  
 Longueurs standards : 1,20 m - 1,80 m - 2,40 m - 3,60 m - 4,80 m - 5,40 m - 7,20 m  
 Autres longueurs nous consulter



Modèle déposé.

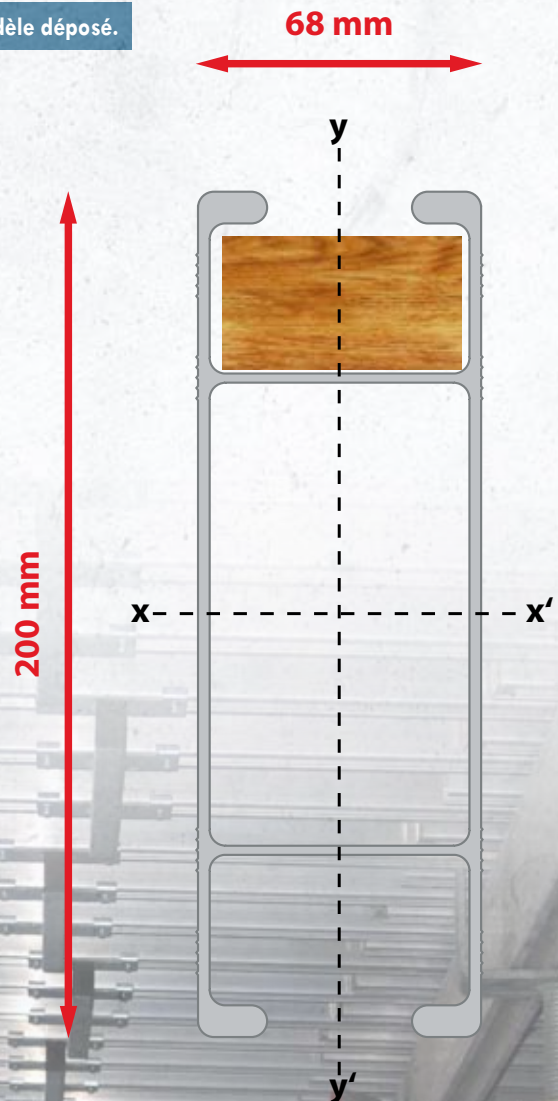



#### Profil Erecta 60/135

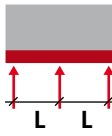
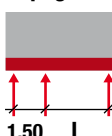

réf. 4900 | 1,20 m - 1,80 m - 2,40 m - 3,60 m - 4,80 m - 5,40 m - 7,20 m

# ABAQUES POUTRELLES 60/165

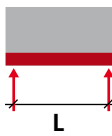
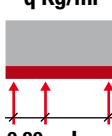
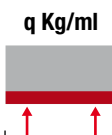
**Profils 60/165 mis sur chant XX'**  
(entraxes pour Touretais Erecta +)

Charge admissible	Portée	Flèche		
	L	1/500	1/400	1/300
 q Kg/ml	1,50	2180	2180	2180
	1,75	1600	1600	1600
	2,00	1160	1230	1230
	2,25	810	960	960
	2,50	590	740	780
	2,75	440	550	645
	3,00	335	420	540
 q Kg/ml	1,75	1450	1800	1800
	2,00	890	1100	1480
	2,25	600	750	1000
	2,50	430	540	720
	2,75	320	400	530
	3,00	245	300	410
 P Kg	0,80	3075	3075	3075
	1,00	2400	2460	2460
	1,25	1540	1970	1970
	1,50	1070	1340	1640
	1,75	750	930	1240
	2,00	600	750	1000
	2,25	475	600	790
	2,50	390	480	650
 q Kg/ml	1,50	1140	1430	1900
	1,75	660	825	1100
	2,00	480	600	800
	2,25	340	420	560
	2,50	250	300	410
	2,75	185	230	310
	3,00	140	180	240
 q Kg/ml	1,50	2000	2500	2900
	1,75	1250	1560	2080
	2,00	780	980	1300
	2,25	490	610	810
	2,50	330	410	550
	2,75	230	290	380
	3,00	170	210	280
 q Kg/ml	1,50	2200	2700	2700
	1,75	1400	1750	1980
	2,00	940	1180	1500
	2,25	660	820	1100
	2,50	480	600	800
	2,75	360	450	600
	3,00	280	350	460

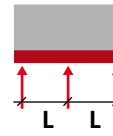
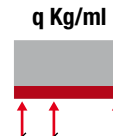
**Profils 60/165 mis sur chant XX'**  
(entraxes pour Touretais Europa 100)

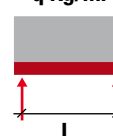
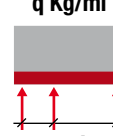
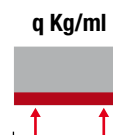
Charge admissible	Portée	Flèche		
	L	1/500	1/400	1/300
 q Kg/ml	1,00	4000	4000	4000
	1,25	3150	3150	3150
	1,50	2180	2180	2180
	1,80	1600	1600	1600
	2,00	1160	1230	1230
	2,25	810	960	960
	2,50	590	740	780
	3,00	335	420	540
 q Kg/ml	1,00	4000	4000	4000
	1,25	3520	3520	3520
	1,50	2100	2800	2800
	1,80	1000	1500	2000
	2,00	860	1100	1450
	2,25	610	760	1000
	2,50	400	500	660
 P Kg	1,00	2400	2460	2460
	1,25	1540	1970	1970
	1,50	1070	1340	1640
	1,80	750	930	1240
	2,00	600	750	1000
	2,25	475	600	790
	2,50	390	480	650
	3,00	240	300	410
 q Kg/ml	1,00	3860	4800	4920
	1,25	1975	2470	3150
	1,50	1140	1430	1900
	1,80	660	825	1100
	2,00	480	600	800
	2,25	340	420	560
	2,50	250	300	410
 q Kg/ml	1,00	1000	1500	2000
	1,25	1230	1550	1925
	1,50	1340	1660	1750
	1,80	1600	1600	1600
	2,00	1050	1300	1350
	2,25	670	830	1100
	2,50	470	580	770
 q Kg/ml	1,00	3860	4800	4920
	1,25	2530	3160	4200
	1,50	2200	2700	2700
	1,80	1400	1750	1980
	2,00	940	1180	1500
	2,25	660	820	1100
	2,50	480	600	800

# ABAQUES POUTRELLES 68/200

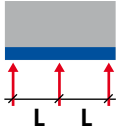
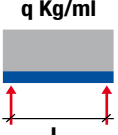
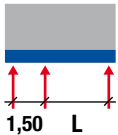
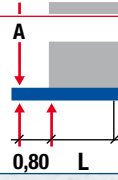
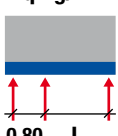
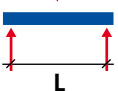
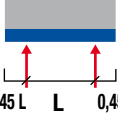
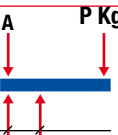

## Profils 68/200 mis sur chant XX' (entraxes pour Touretais Erecta +)

Charge admissible	Portée	Flèche			Service		Charge admissible	Portée	Flèche			Service	
	L	1/500	1/400	1/300	1/200	1/100		L	1/500	1/400	1/300	1/200	1/100
<b>q Kg/ml</b> 	1,00	7760	7760	7760	7760	7760	<b>q Kg/ml</b> 	1,00	10000	10000	10000	10000	10000
	1,50	5060	5060	5060	5060	5060		1,50	3230	4040	5060	5060	5060
	1,75	3700	3700	3700	3700	3700		1,75	2030	2540	3390	3700	3700
	2,00	2850	2850	2850	2850	2850		2,00	1360	1700	2270	2850	2850
	2,25	2250	2250	2250	2250	2250		2,25	960	1200	1600	2250	2250
	2,50	1650	1820	1820	1820	1820		2,50	700	875	1160	1740	1820
	2,75	1240	1500	1500	1500	1500		2,75	520	650	870	1300	1500
	3,00	970	1210	1260	1260	1260		3,00	400	500	670	1000	1260
	3,50	610	770	930	930	930		4,00	170	210	280	425	710
<b>q Kg/ml</b> 	1,75	4100	4100	4100	4100	4100	<b>A</b> 	0,80	1330	1660	2220	3330	4450
	2,00	2500	3100	3450	3450	3450		1,00	810	1010	1350	2020	2850
	2,25	1700	2100	2800	2900	2900		1,50	320	400	530	800	1260
	2,50	1200	1500	2000	2350	2350		2,00	160	200	270	410	820
	2,75	900	1100	1500	2000	2000							
	3,00	700	865	1150	1700	1700							
	3,25	530	660	890	1330	1400							
	3,50	460	580	770	1160	1200							
	<b>q Kg/ml</b> 	1,50	6000	6400	6400	6400		6400	<b>P Kg</b> 	0,80	7125	7125	7125
1,75		3900	4800	4900	4900	4900	1,00	5700		5700	5700	5700	5700
2,00		2200	2750	3600	4100	4100	1,50	3000		3800	3800	3800	3800
2,25		1370	1720	2290	3000	3000	1,75	2230		2790	3250	3250	3250
2,50		925	1155	1540	2290	2290	2,00	1700		2120	2850	2850	2850
2,75		660	820	1100	1640	1810	2,25	1340		1680	2240	2530	2530
3,00		490	610	810	1220	1475	2,50	1090		1360	1820	2280	2280
3,25		370	460	620	930	1225	2,75	900		1125	1500	2070	2070
3,50		290	360	480	720	1030	3,00	750		940	1200	1900	1900
<b>q Kg/ml</b> 	1,50	4180	5230	6250	6250	6250	<b>P Kg</b> 	0,80	415	520	690	1030	1780
	1,75	2540	3175	4230	4590	4590		1,00	235	295	390	590	1180
	2,00	1750	2180	2910	3500	3500		1,50	-	-	-	200	410
	2,25	1250	1550	2050	2780	2780		2,00	-	-	-	95	190
	2,50	860	1080	1400	2150	2250							
	2,75	660	820	1100	1650	1860							
	3,00	510	650	860	1140	1560							



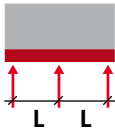
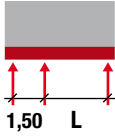
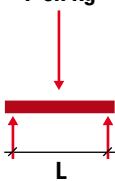

# ABAQUES POUTRELLES À PLAT

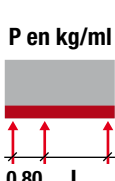
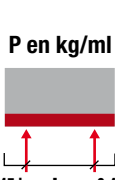
**Profil 60/165 mis sur chant YY'**  
(entraxes pour Touretais Erecta +)

Charge admissible	Portée	Flèche		
	L	1/500	1/400	1/300
<b>P en kg/ml</b> 	1,50	560	700	930
	1,75	350	440	590
	2,00	235	300	400
	2,25	165	205	275
	2,50	120	150	200
	2,75	90	110	150
	3,00	70	85	110
<b>P en kg/ml</b> 	1,75	295	370	490
	2,00	180	220	300
	2,25	120	150	200
	2,50	90	110	145
	2,75	65	80	110
	3,00	50	60	80
<b>P en kg</b> 	0,80	760	950	1270
	1,00	490	610	810
	1,25	310	390	520
	1,50	220	270	360
	1,75	160	200	270
	2,00	120	150	200
	2,25	100	120	160
	2,50	80	100	130
<b>P en kg/ml</b> 	1,50	230	290	390
	1,75	150	180	245
	2,00	100	120	160
	2,25	70	85	115
	2,50	50	60	85
	2,75	40	50	60
	3,00	30	35	45
<b>P en kg/ml</b> 	1,50	400	500	680
	1,75	250	320	420
	2,00	160	200	265
	2,25	100	125	165
	2,50	65	80	110
	2,75	45	60	80
	3,00	35	45	60
<b>P en kg/ml</b> 	1,50	450	560	750
	1,75	285	355	475
	2,00	190	240	320
	2,25	135	170	220
	2,50	100	120	160
	2,75	70	90	120
	3,00	55	70	95

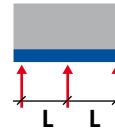
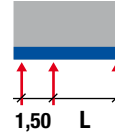
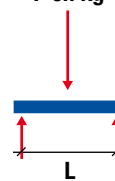
**Profil 68/200 mis sur chant YY'**  
(entraxes pour Touretais Europa 100)

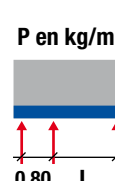
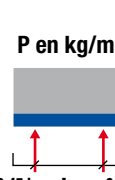
Charge admissible	Portée	Flèche		
	L	1/500	1/400	1/300
<b>P en kg/ml</b> 	1,50	1260	1570	2100
	1,75	790	980	1300
	2,00	530	660	880
	2,25	370	460	620
	2,50	270	340	450
	2,75	200	250	330
	3,00	160	200	260
<b>P en kg/ml</b> 	1,75	680	820	1100
	2,00	400	500	670
	2,25	270	330	450
	2,50	200	250	330
	2,75	145	180	240
	3,00	110	140	185
<b>P en kg</b> 	0,80	1700	2150	2870
	1,00	1100	1370	1840
	1,25	700	870	1160
	1,50	490	610	810
	1,75	360	450	600
	2,00	275	345	460
	2,25	220	280	370
	2,50	175	220	290
<b>P en kg/ml</b> 	1,50	520	650	870
	1,75	330	420	560
	2,00	220	275	370
	2,25	150	200	260
	2,50	110	140	190
	2,75	90	110	150
	3,00	65	80	110
<b>P en kg/ml</b> 	1,50	900	1100	1500
	1,75	560	700	900
	2,00	360	450	600
	2,25	220	280	370
	2,50	140	180	240
	2,75	100	125	170
	3,00	80	100	130
<b>P en kg/ml</b> 	1,50	670	840	1100
	1,75	420	520	700
	2,00	280	350	470
	2,25	200	250	330
	2,50	140	180	240
	2,75	100	130	180
	3,00	80	100	140

# ACCESSOIRES

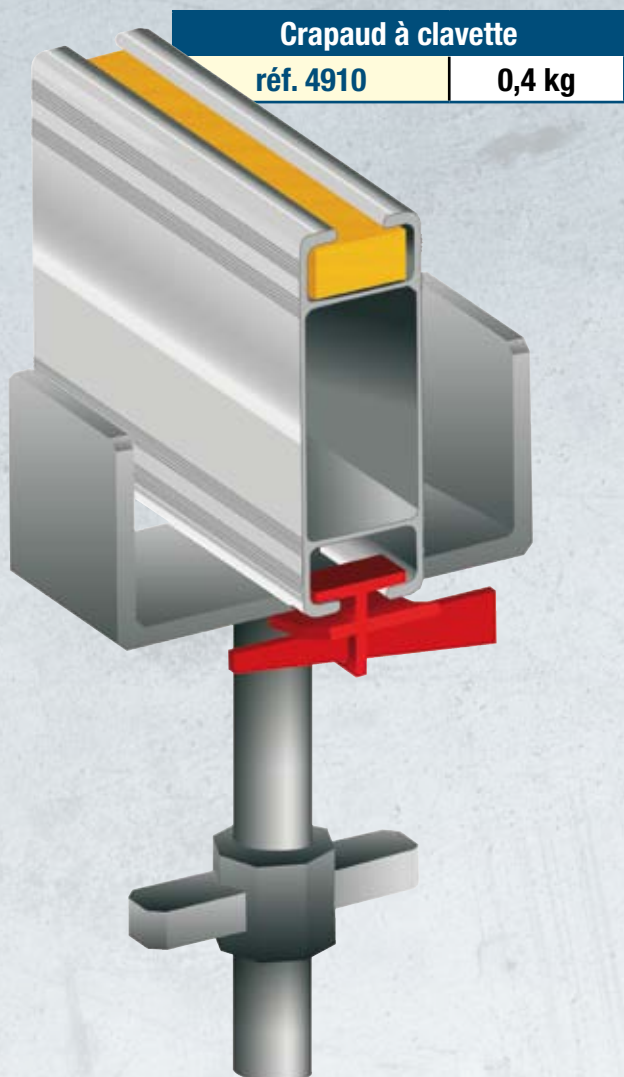

**Crapaud à clavette**

réf. 4910

0,4 kg

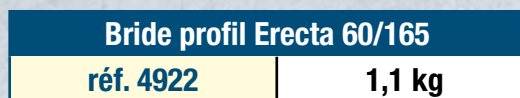

**Bride profil Erecta 60/165**

réf. 4922

1,1 kg

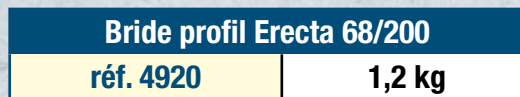

**Bride profil Erecta 68/200**

réf. 4920

1,2 kg



**Arrêt de dalle**

réf. 4955

hauteur 0,30 m

6,5 kg

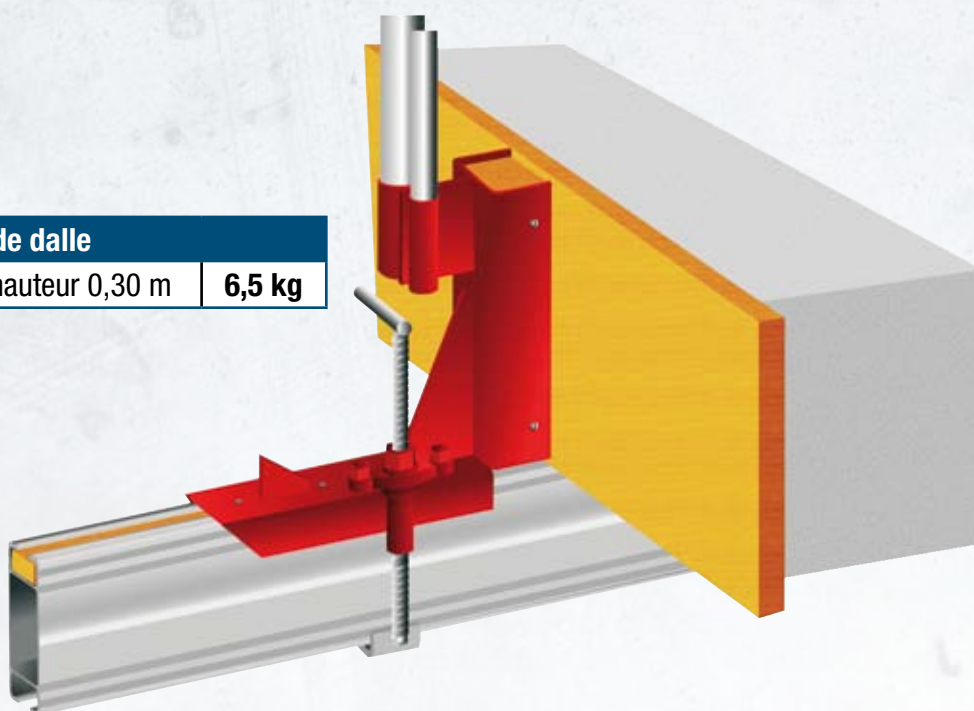

# ACCESSOIRES

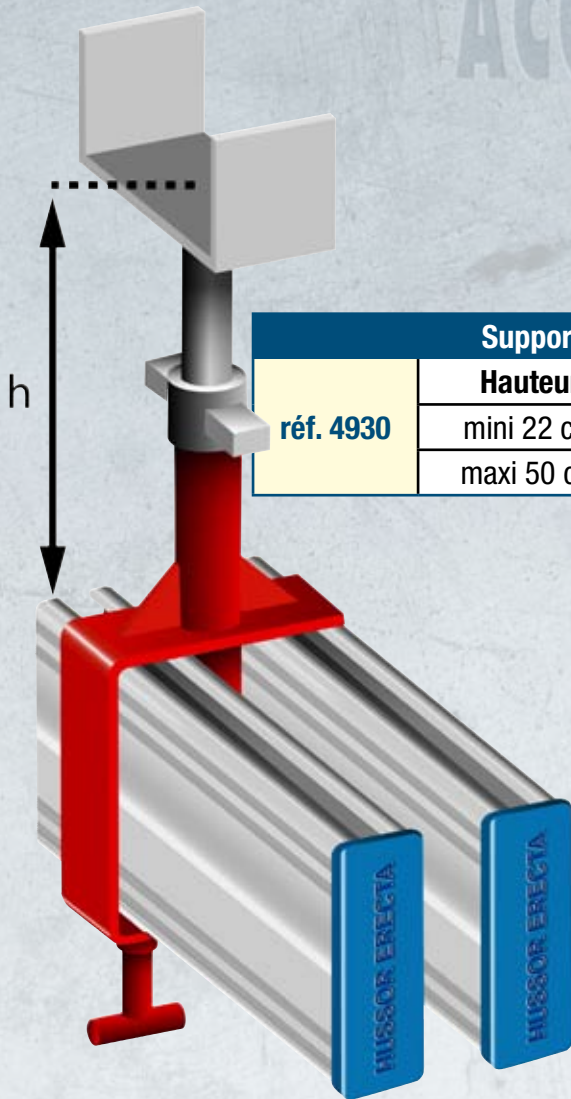

Support poteau			
réf. 4930	<b>Hauteur</b>	<b>Charge</b>	<b>Poids</b>
	mini 22 cm maxi 50 cm	1500 daN	4,5 kg



Pince poutrelle (ou tube) à clavette	
réf. 4915	0,7 kg



Coulisseau de poutre		
réf. 4968	ø 28 + ø 40	3 kg

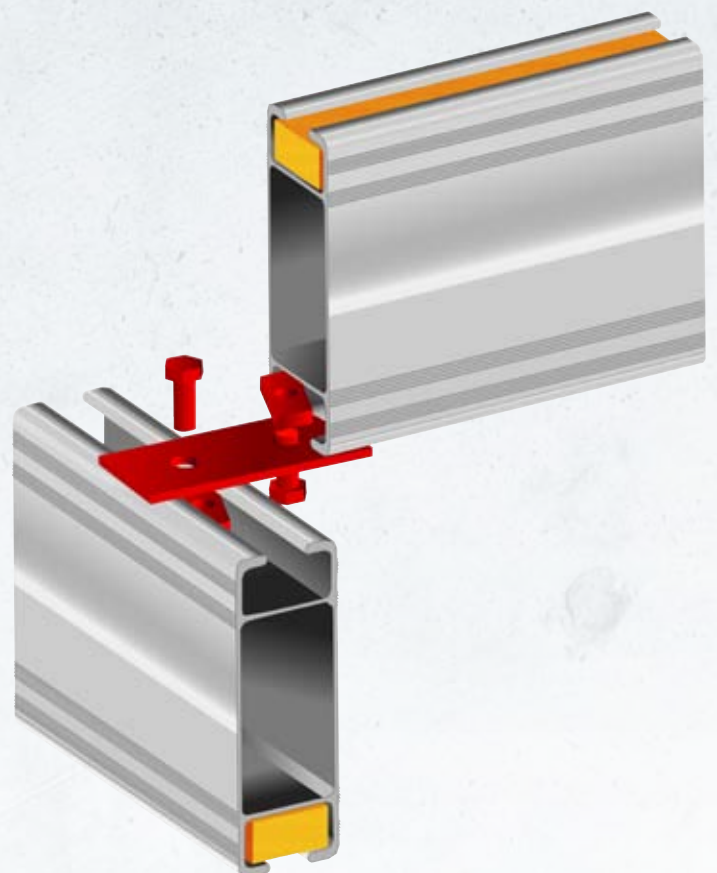

Plaque de liaison à boulons	
réf. 4919	0,5 kg

# COFFRAGE HORIZONTAL

PS3

Le système PS3 est un ensemble de 3 poutrelles alu ERECTA 50/80 reliées par un «peigne». Ce système permet de coffrer des dalles béton jusqu'à 25 cm d'épaisseur, sans risque de chute pour le personnel (plus, nous consulter).

Son faible poids : 14,3 kg en fait un outil maniable et simple d'utilisation.

Le montage du PS3 se fait depuis le sol. Le croisement systématique des panneaux permet d'obtenir une circulation de 30 cm. L'espacement réduit des poutrelles alu 50/80 (12,6 cm) supprime tout risque de chute et autorise le passage des étais de séchages.

La poutrelle centrale du panneau dispose d'une fourrure bois, ce qui permet le clouage du contreplaqué.

Des poutrelles «solitaires» 50/80 viennent compléter le système en les positionnant aux endroits où l'on souhaite clouer (joint de plaque, zone exigüe...).

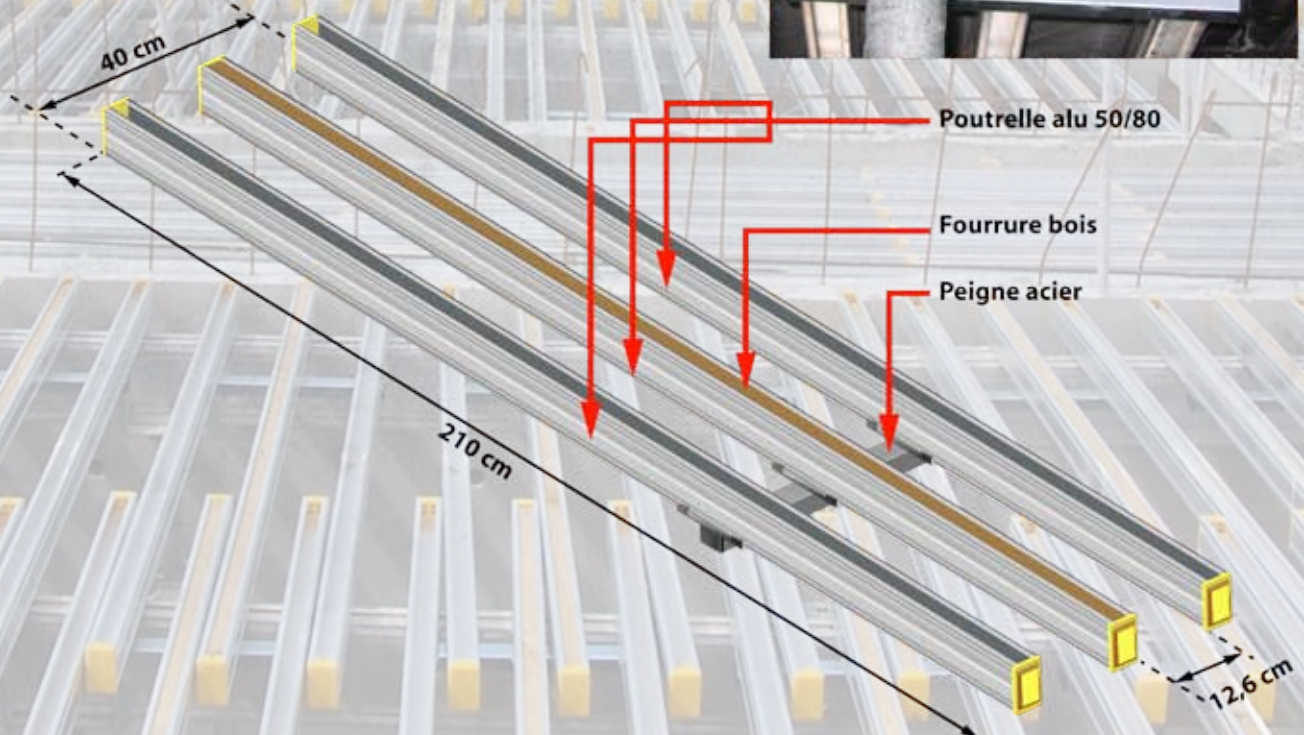



# COFFRAGE HORIZONTAL

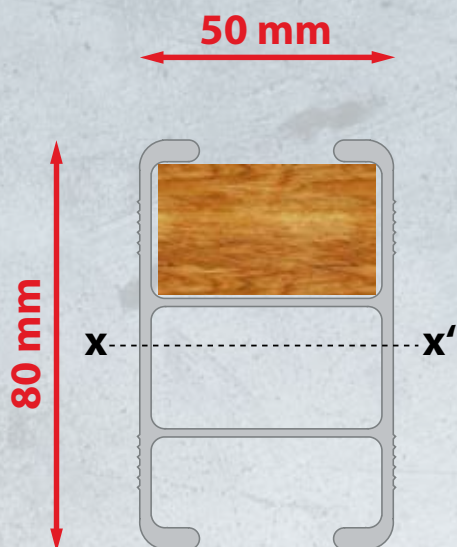

## PROFIL 50/80

Section : 6 cm<sup>2</sup>  
 Moment d'inertie  $xx'$  : 38,76 cm<sup>4</sup>  
 Module d'inertie  $xx'$  : 9,43 cm<sup>3</sup>  
 Moment de flexion  $xx'$  : 245 daN.M  
 T admissible  $xx'$  : 1250 daN  
 Poids au mètre linéaire : 1,64 kg

Modèle déposé.

PS1

réf. 4990.2100

PS3

réf. 4995.2100



## CAS DE CHARGE

Portée «L» maxi en cm en fonction de l'épaisseur de la dalle en béton et de la flèche souhaitée.

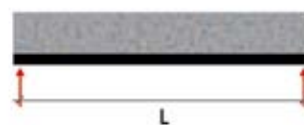

Arrêt de dalle	18	19	20	21	22	23	24	25
Flèche 1/500	179	177	175	174	172	170	169	168
Flèche 1/400	188	186	184	182	181	179	177	176
Flèche 1/300	200	199	197	195	193	191	189	187

Densité du béton : 2500 daN/m<sup>3</sup> - Coffrage 50 daN/m<sup>2</sup> - Entraxe profil 17,5 cm

# ELEMENTS DE BASE

**PS3**

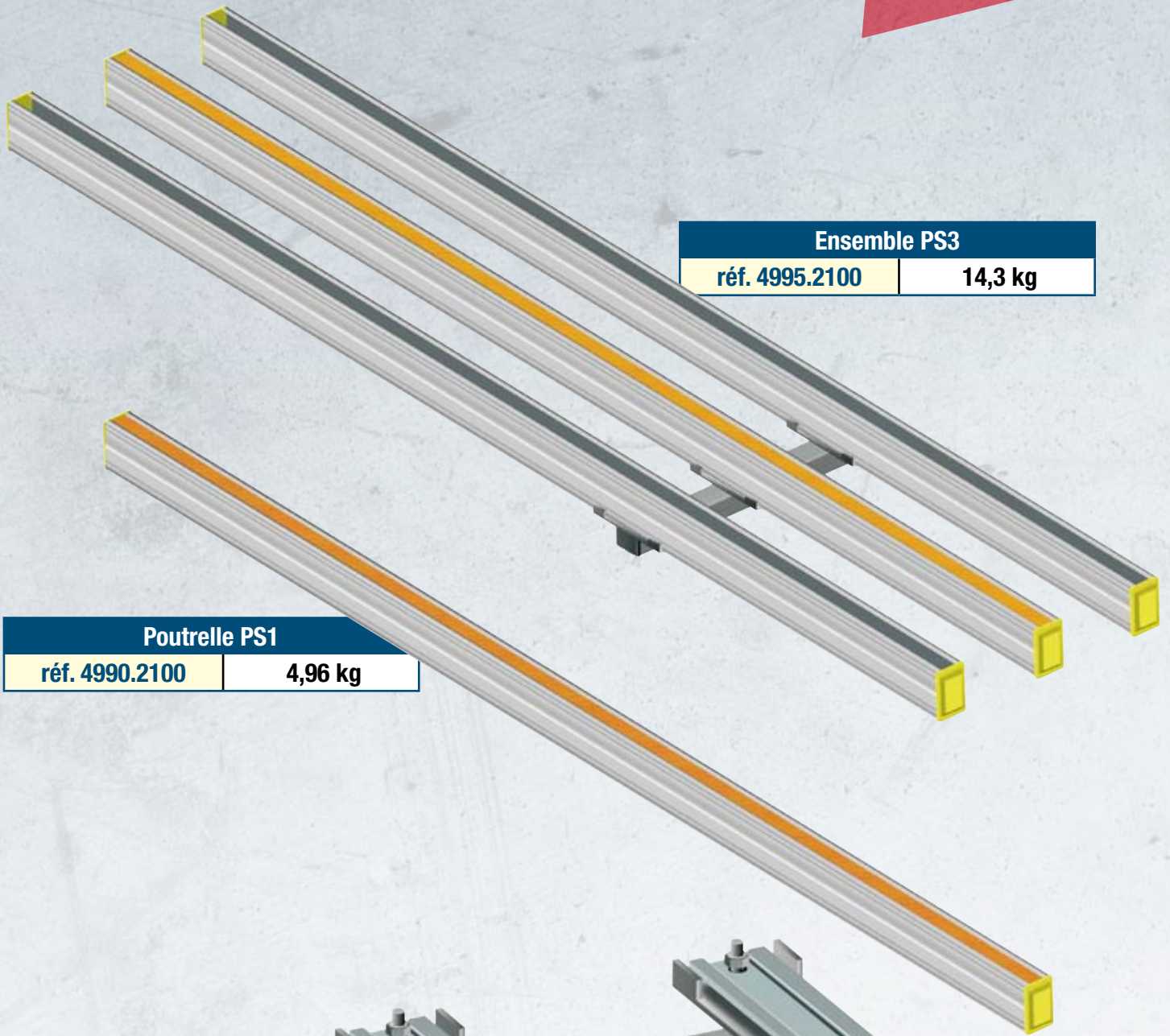

Ensemble PS3	
réf. 4995.2100	14,3 kg

Poutrelle PS1	
réf. 4990.2100	4,96 kg



Peigne PS3	
réf. 4993	2,04 kg

### Bride PS3

réf. 4996

hauteur 16,50 cm

0,6 kg

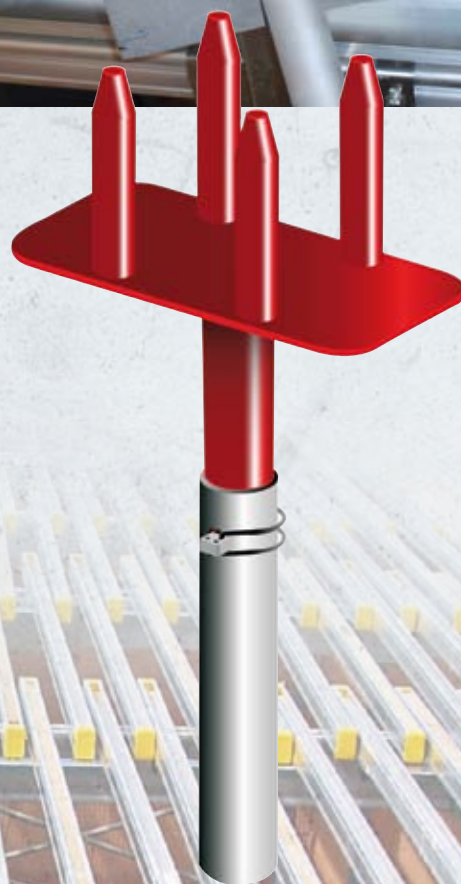

### Fourche de pose PS3

réf. 4994

6 kg

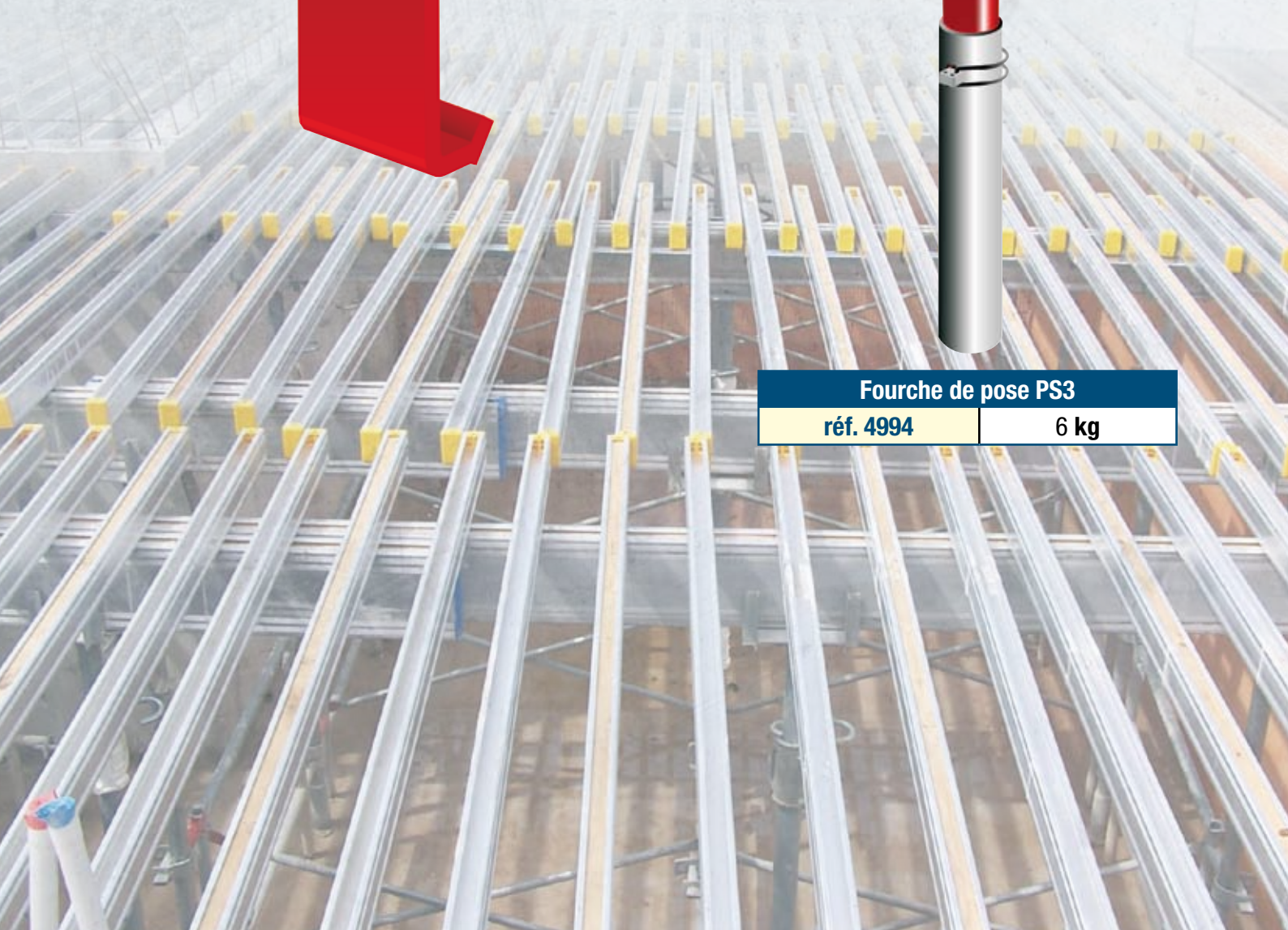

# ABAQUES PS3

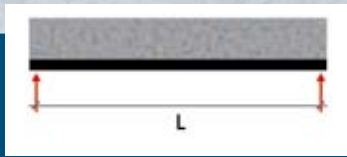

## Cas 1

Epaisseur de la dalle	Poids au m <sup>2</sup>	Portée	Flèche		
		L	1/500	1/400	1/300
0,18	500	1,00	x		
		1,25	x		
		1,50	x		
		1,80		x	
		1,90			
0,19	525	1,00	x		
		1,25	x		
		1,50	x		
		1,80			x
		1,90			
0,20	550	1,00	x		
		1,25	x		
		1,50	x		
		1,80			x
		1,90			
0,21	575	1,00	x		
		1,25	x		
		1,50	x		
		1,80			x
		1,90			
0,22	600	1,00	x		
		1,25	x		
		1,50	x		
		1,80			x
		1,90			
0,23	625	1,00	x		
		1,25	x		
		1,50	x		
		1,80			x
		1,90			
0,24	650	1,00	x		
		1,25	x		
		1,50	x		
		1,80			x
		1,90			
0,25	675	1,00	x		
		1,25	x		
		1,50	x		
		1,80			x
		1,90			

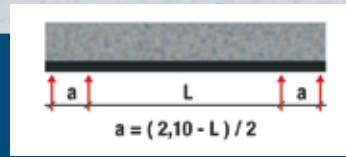

## Cas 2

Epaisseur de la dalle	Poids au m <sup>2</sup>	Portée	Flèche			
		L	1/500	1/400	1/300	
0,18	500	1,00	x			
		1,25	x			
		1,50	x			
		1,80			x	
		1,90				x
0,19	525	1,00	x			
		1,25	x			
		1,50	x			
		1,80			x	
		1,90				x
0,20	550	1,00	x			
		1,25	x			
		1,50	x			
		1,80			x	
		1,90				x
0,21	575	1,00	x			
		1,25	x			
		1,50	x			
		1,80			x	
		1,90				x
0,22	600	1,00	x			
		1,25	x			
		1,50	x			
		1,80			x	
		1,90				x
0,23	625	1,00	x			
		1,25	x			
		1,50	x			
		1,80			x	
		1,90				x
0,24	650	1,00	x			
		1,25	x			
		1,50	x			
		1,80			x	
		1,90				
0,25	675	1,00	x			
		1,25	x			
		1,50	x			
		1,80			x	
		1,90				

# MONTAGE EN SÉCURITÉ

PS3



**1** Montage des tours et pose des poutrelles primaires

Pose des PS3 depuis le sol **2**

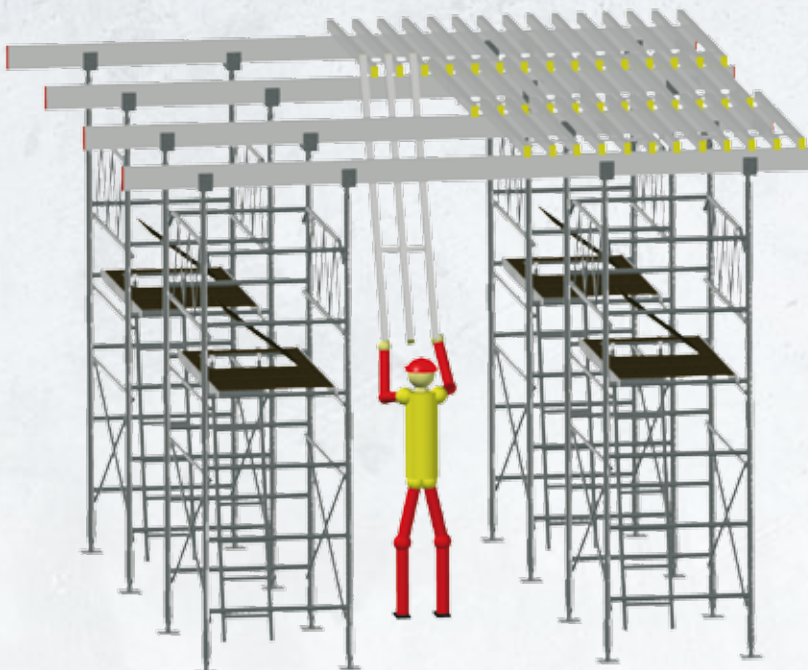
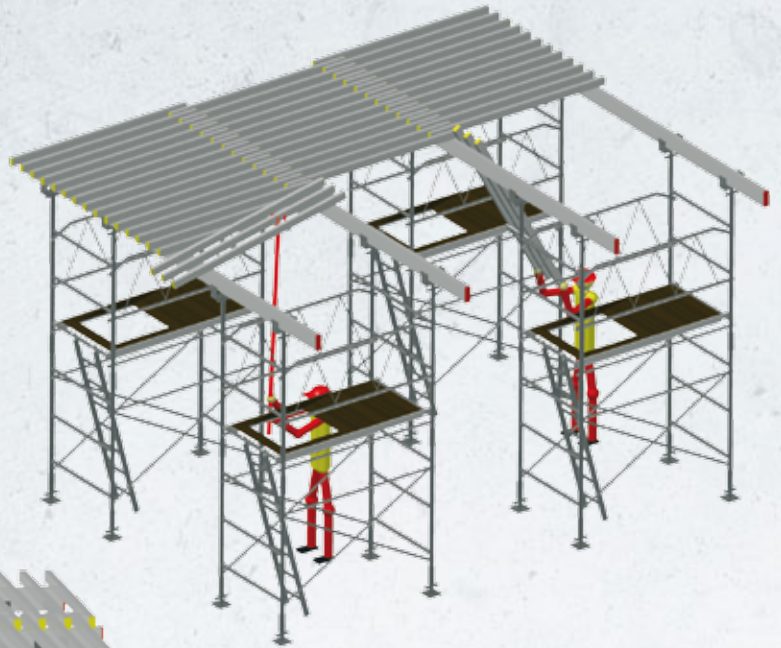

**3** Appui de la PS3 sur la première poutrelle primaire

# MONTAGE EN SÉCURITÉ

PS3

- 4** Mise en place de l'outil de pose pour relever et aligner la PS3 au dessus des poutrelles primaires

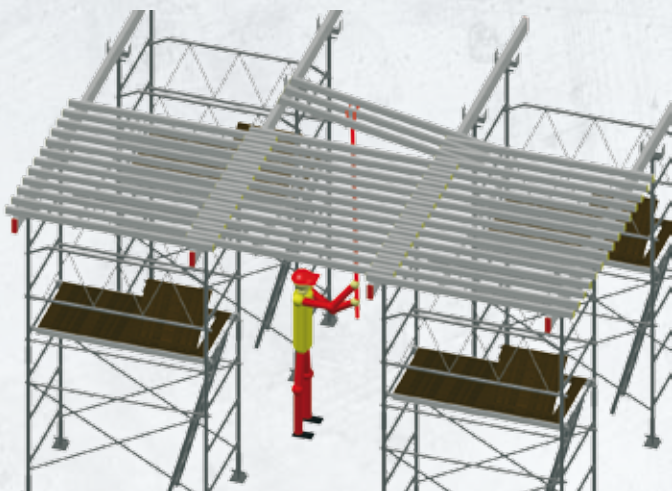
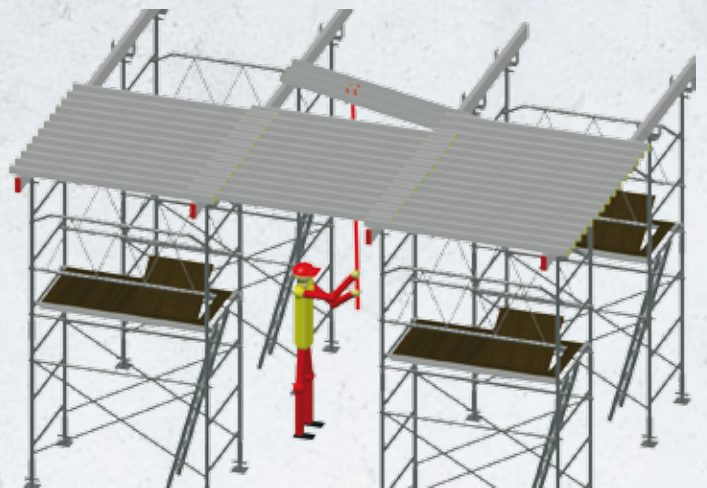
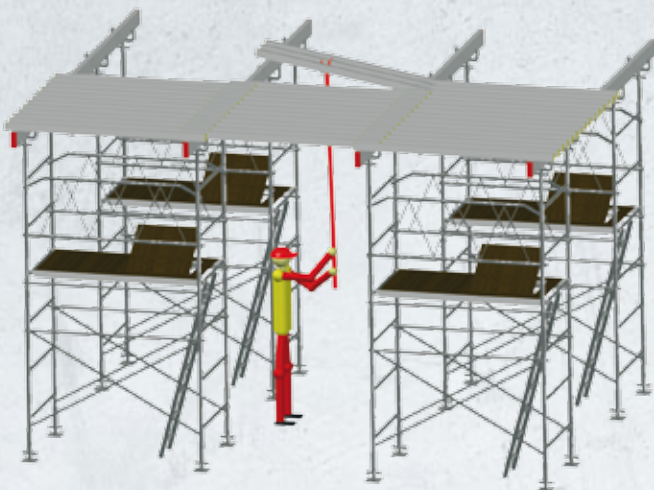
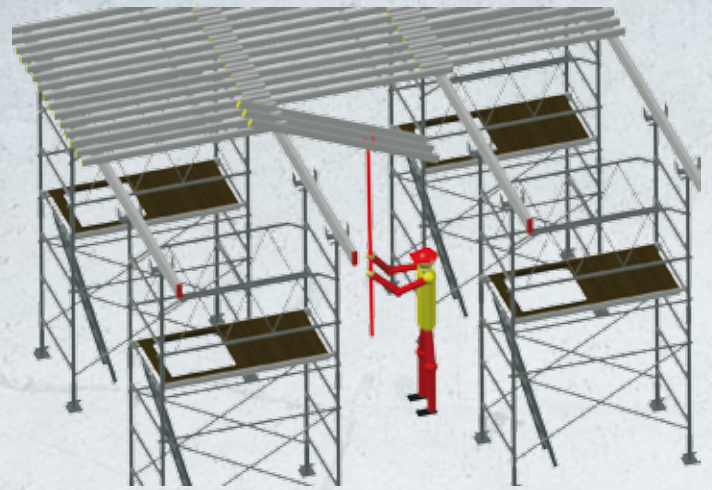
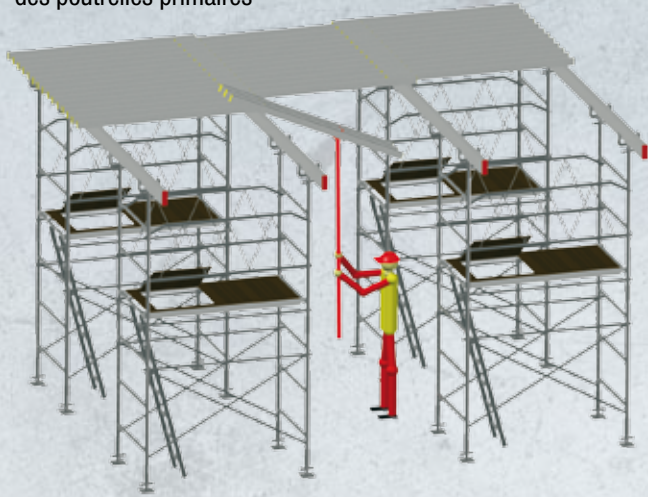

- 5** Pose du contreplaqué sans risque de chute

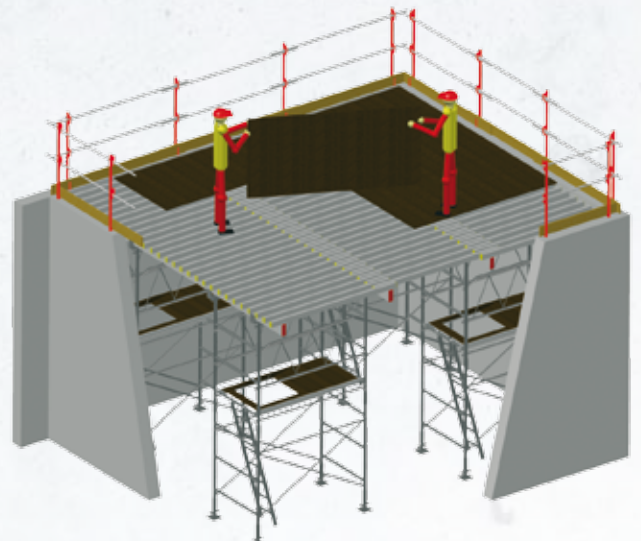

# CASIERS DE RANGEMENT



**Casier démontable**

<b>réf. 1455</b>	33 PS = 20 PS1	<b>64 kg à vide</b>
	60 x 60 /165 44 x 68/200	

**Casier de ripage**

<b>réf4999</b>	20 PS3	<b>52 kg à vide</b>
----------------	--------	---------------------





# Nos sites

## MAITRISER SON DEVELOPPEMENT

Hussor Erecta dirige ses efforts vers de nouveaux produits plus sûrs, plus légers et plus faciles à mettre en œuvre. Etudes, mise au point de prototypes ainsi que les essais aboutissent à des matériels de plus en plus performants. Afin de proposer à ses clients une même chaîne de qualité de produits et de services, la société implante progressivement des agences dans l'hexagone.



**ECHAFAUDAGE**

**ÉTAIEMENT**

**VENTE**

**LOCATION**

**MONTAGE**



Qualifications (OPQCB)  
1413 Echafaudages fixes (technicité supérieure)  
1433 Tribunes et podiums (technicité supérieure)  
1443 Etalements (technicité supérieure)



Membre du syndicat français de l'échafaudage, du coffrage et de l'étalement

**HUSSOR ERECTA**



**SIÈGE** : ZI de Hachimette - 336, La Croix d'Orbey - BP 19 - 68650 LAPOUTROIE (France) - Tél. 03 89 47 57 37 - Fax 03 89 47 57 08 - lapoutroie@hussor-erecta.fr



Latitude : 48.144223 Longitude : 7.182961

**AGENCE NORD** : 59113 SECLIN (France) - Tél. 03 20 90 96 90 - Fax 03 20 32 54 29 - seclin@hussor-erecta.fr



Latitude : 50.5667416 Longitude : 3.0329672999999957

**AGENCE NORMANDIE** : 76170 LILLEBONNE (France) - Tél. 02 35 39 03 10 - Fax 02 35 38 26 23 - lillebonne@hussor-erecta.fr



Latitude : 49.477205 Longitude : 0.532193

**AGENCE ILE DE FRANCE (LMB)** : 95300 Ennery - Tél. 01 34 25 96 46 - Fax 01 30 30 53 45 - lmb@hussor-erecta.fr



Latitude : 49.068554 Longitude : 2.114084